

E Series Servo Drive

Gantry Control System
User Manual

Revision History

The version of the manual is also indicated on the bottom of the front cover.

MD22UE01-2408_V1.4

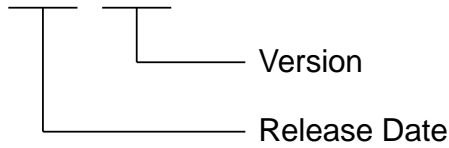

Release Date	Version	Applicable Product	Revision Contents
Aug. 31 st , 2024	1.4	E1 series servo drive E2 series servo drive	<ol style="list-style-type: none"> 1. Update section 3.4 Activate gantry control system. 2. Add section 3.5 Digital input/output signals configuration. 3. Delete original section 6.4 Multi-motion function (not supported). 4. Delete original section 6.5 Position trigger function (not supported). 5. Add section 6.9 Position trigger function.
Dec. 15 th , 2023	1.3	E1 series servo drive E2 series servo drive	<ol style="list-style-type: none"> 1. Update Preface. 2. Update chapter 7 Gantry control interface setting.
May 31 st , 2023	1.2	E1 series servo drive E2 series servo drive	<ol style="list-style-type: none"> 1. Update manual's name. 2. Add the information related to E2 series servo drive: servo drive firmware version, applicable model, hardware configuration. 3. Add section 2.2.2: Provide control block diagram for gantry control system. 4. Move section 3.5 in version 1.1 to section 6.9. 5. Move section 3.6 in version 1.1 to section 6.10. 6. Add section 3.5~3.7. 7. Add section 6.2~6.8, section 6.10.1 and section 6.10.2.
Apr. 30 th , 2020	1.1	E1 series servo drive	<ol style="list-style-type: none"> 1. Update section 3.5: <ul style="list-style-type: none"> ✓ When using a multi index encoder, users should adopt near home sensor input (DOG) signal on both axes.

Release Date	Version	Applicable Product	Revision Contents
			<ul style="list-style-type: none"> ✓ Add figures to illustrate the definition of home position. 2. Add section 3.6: <ul style="list-style-type: none"> ✓ Describe touch probe function and offer the list of the related objects. ✓ Add figures to illustrate the installation limit of near home sensor. 3. Add description tables for Pt parameters in section 3.2, section 3.4, section 3.5, section 4.2, section 4.3 and section 6.1.
Oct. 15 th , 2019	1.0	E1 series servo drive	First edition.

Related Documents

Through related documents, users can quickly understand the positioning of this manual and the correlation between manuals and products. Go to HIWIN MIKROSYSTEM's official website → Download → Manual Overview for details (https://www.hiwinmikro.tw/Downloads/ManualOverview_EN.htm).

Firmware Change History

Refer to “E1 Series Servo Drive User Manual” and “E2 Series Servo Drive User Manual” for the information of servo drive firmware version.

■ E1 series servo drive

Servo Drive Firmware Version	Revision Contents related to Functions of Gantry Control System
2.12.0	<ol style="list-style-type: none"> 1. Gantry control system supports position trigger function. 2. Support gantry control input (GANTRY) signal and gantry control ready output (G-RDY) signal.
2.8.9	The default of Pt010 = t.□X□□ - Gantry enable method selection is changed to “Use gantry enable method 2.”
2.4.6	<ol style="list-style-type: none"> 1. Optimize the searching DOG signal procedure in internal homing. Users can detect single axis or both axes with Pt parameters. 2. Fieldbus type servo drive supports Touch Probe function: also for multi index encoders. (refer to section 6.8 Touch Probe procedure for the requirements.)
2.3.12	<ol style="list-style-type: none"> 1. Change the searching DOG signal procedure in internal homing from detecting single axis to detecting both axes. 2. Fieldbus type servo drive supports Touch Probe function: only for single index encoders.
2.2.8	Support functions of gantry control system.

■ E2 series servo drive

Servo Drive Firmware Version	Revision Contents related to Functions of Gantry Control System
3.12.0	<ol style="list-style-type: none"> 1. Gantry control system supports position trigger function. 2. Support gantry control input (GANTRY) signal and gantry control ready output (G-RDY) signal.
3.9.10	Support functions of gantry control system.

Preface

This manual explains the hardware configuration, setting procedure, parameters and application functions related to E series gantry control system. On the mechanical platform that drives the two-axis gantry structure, excellent motion response and accuracy control can be achieved through the gantry control algorithm of linear synchronization and posture control.

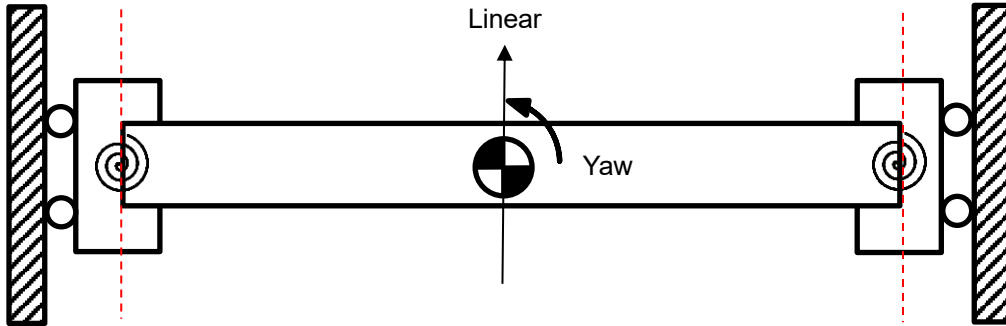

Table of Contents

1.	Hardware configuration.....	1-1
2.	System architecture.....	2-1
2.1	Communication system architecture.....	2-2
2.2	Control system architecture.....	2-2
2.2.1	Definition of linear/yaw axis	2-2
2.2.2	Control block diagram for gantry control system.....	2-3
2.2.3	Definition of linear/yaw axis direction	2-4
3.	Setting procedure.....	3-1
3.1	Single axis setting.....	3-2
3.2	Establish communication system.....	3-3
3.3	Confirmation before activating gantry control system.....	3-5
3.4	Activate gantry control system.....	3-6
3.5	Digital input/output signals configuration.....	3-7
3.6	Overtravel function.....	3-8
3.7	Overload protection setting	3-8
3.8	Electronic gear ratio setting.....	3-8
4.	Gain tuning.....	4-1
4.1	Single axis gain tuning	4-2
4.2	Gantry control gain tuning	4-2
4.3	Current ratio parameter.....	4-4
4.4	Velocity ripple compensation (not supported)	4-5
5.	Safety protection function	5-1
5.1	Enable/Disable axes in gantry control system.....	5-2
5.2	Motor stopping methods for alarm.....	5-2
5.3	Relevant alarms.....	5-3
6.	Application function	6-1
6.1	Error map.....	6-2
6.2	Torque limit function	6-4
6.3	Full-closed loop function.....	6-4
6.4	Velocity mode	6-4
6.5	Torque mode.....	6-4
6.6	Encoder pulse output	6-5
6.7	Internal homing procedure	6-5
6.8	Touch Probe procedure.....	6-11

6.8.1	HIMC with Touch Probe	6-14
6.8.2	MECHATROLINK-III with Touch Probe (not supported).....	6-14
6.9	Position trigger function.....	6-15
7.	Gantry control interface setting	7-1

1. Hardware configuration

1. Hardware configuration.....	1-1
--------------------------------	-----

■ E1 series servo drive

Select the model supporting gantry function and connect two servo drives via CN8 with the communication cable.

Table 1.1

Type	Control Interface	Model
Standard	Voltage command and pulse	ED1S-VG-□□□□-□□-□□
Fieldbus	EtherCAT	ED1F-EG-□□□□-□□-□□
	mega-ulink (For HIMC motion controller)	ED1F-HG-□□□□-□□-□□
	MECHATROLINK-III	ED1F-LG-□□□□-□□-□□



Figure 1.1 CN8 position

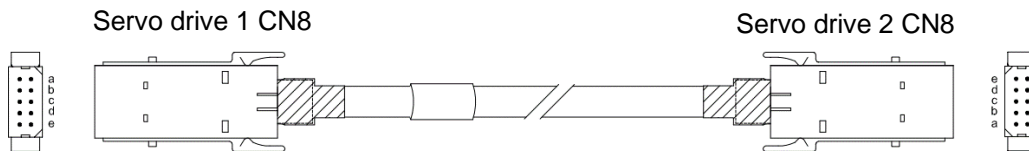

Figure 1.2 Servo drive communication cable (for gantry control system)

Table 1.2 Communication cable for gantry function

Name	HIWIN Part Number	Description
Servo drive communication cable	HE00EJ6DD000	Connect two servo drives which both support gantry function via CN8. (0.5 m)

■ E2 series servo drive

Select the model supporting gantry function and connect two servo drives via CN8 with the communication cable.

Table 1.3

Type	Function	Model
Standard	AC	ED2S-□□-□□□-□A-□□
	Advanced	ED2S-□□-□□□-□C-□□
	GT	ED2S-□□-□□□-□T-□□
Fieldbus	AC	ED2F-□□-□□□-□A-□□
	Advanced	ED2F-□□-□□□-□C-□□
	GT	ED2F-□□-□□□-□T-□□



Figure 1.3 CN8 position

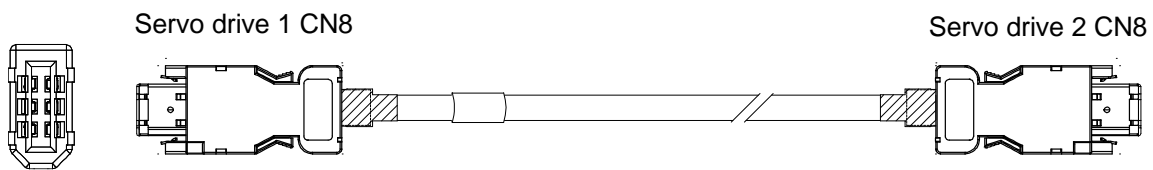

Figure 1.4 Servo drive communication cable (for gantry control system)

Table 1.4 Communication cable for gantry function

Name	HIWIN Part Number	Description
Servo drive communication cable	HE00EK5DB800	Connect two servo drives which both support gantry function via CN8. (0.5 m)

(This page is intentionally left blank.)

2. System architecture

2.	System architecture.....	2-1
2.1	Communication system architecture.....	2-2
2.2	Control system architecture.....	2-2
2.2.1	Definition of linear/yaw axis	2-2
2.2.2	Control block diagram for gantry control system.....	2-3
2.2.3	Definition of linear/yaw axis direction	2-4

To build a complete gantry control system, two servo drives, two motors and the corresponding encoders must be prepared as two axes. Before activating gantry control system through setting, establish communication system between two servo drives first.

2.1 Communication system architecture

Connect CN8 via the cable (refer to “E1 Series Servo Drive User Manual” and “E2 Series Servo Drive User Manual”) and establish communication system (refer to section 3.2). In communication system, the relationship of master and slave exists in the two servo drives.

2.2 Control system architecture

2.2.1 Definition of linear/yaw axis

After establishing communication system, users can enter gantry control system via gantry control interface (refer to chapter 7). After entering gantry control system, two axes' linear (axis 0 and axis 1) coordinate system will respectively become **linear coordinate system** and **yaw coordinate system**. The relationship between “Master/Slave” and “Linear/Yaw” is described as follows.

Master axis → Linear axis

Slave axis → Yaw axis

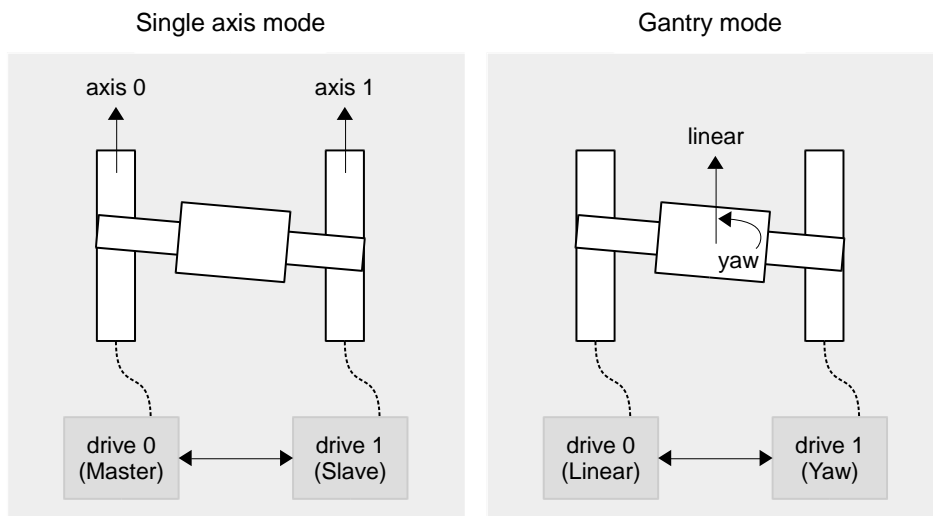

Figure 2.2.1.1

2.2.2 Control block diagram for gantry control system

Before entering gantry control system, the two axes belong to single axis control system. Refer to “E1 Series Servo Drive User Manual” and “E2 Series Servo Drive User Manual” for its control block diagram.

After entering gantry control system, its control block diagram is shown as follows.

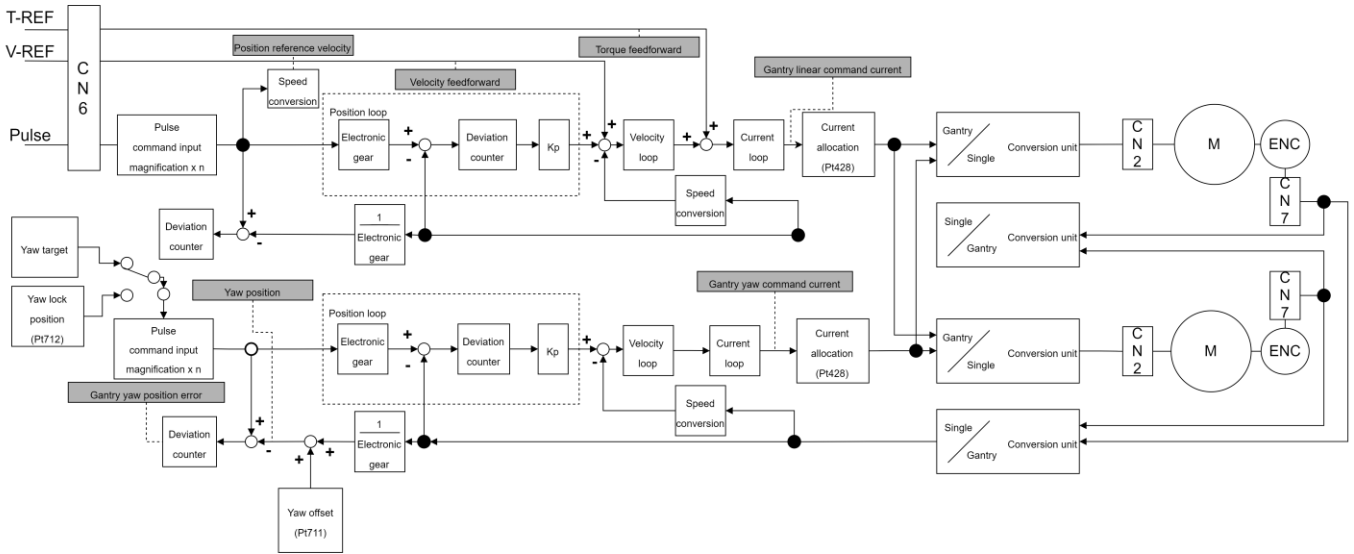

Figure 2.2.2.1

Table 2.2.2.1 Physical quantities which can be monitored

Physical Quantity
(3) Position reference velocity
(5) Velocity feedforward
(8) Torque feedforward
(19) Yaw position
(23) Gantry linear command current
(24) Gantry yaw command current
(25) Gantry yaw position error

2.2.3 Definition of linear/yaw axis direction

■ Definition of linear axis direction

The linear positive direction of single axis moving part is the positive direction of linear axis.

■ Definition of yaw axis direction

If the positive direction of linear axis and the position of master axis are already known, the positive direction of yaw axis can be determined by gantry right-hand rule, as the following figure shows.

Master: It is the direction pointing to master axis.

Linear+: It is the positive direction of linear axis movement.

Yaw+: It is the axial direction of yaw axis. As the following figure shows, the thumb pointing up indicates the positive direction of yaw axis movement is counterclockwise; conversely, the thumb pointing down indicates the positive direction of yaw axis movement is clockwise.

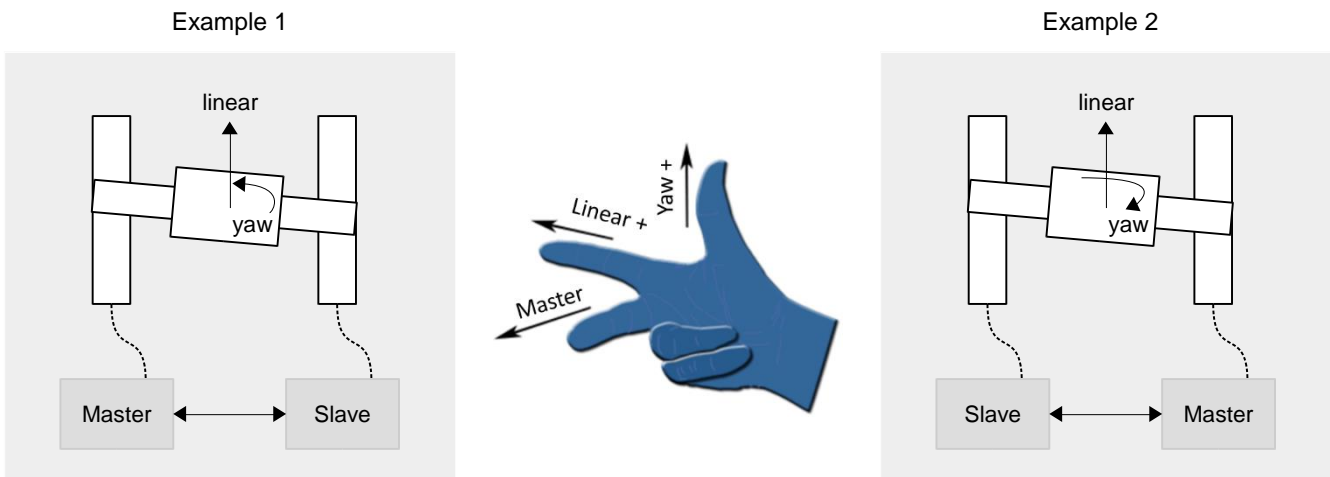

Figure 2.2.3.1

3. Setting procedure

3.	Setting procedure	3-1
3.1	Single axis setting	3-2
3.2	Establish communication system.....	3-3
3.3	Confirmation before activating gantry control system	3-5
3.4	Activate gantry control system.....	3-6
3.5	Digital input/output signals configuration.....	3-7
3.6	Overtravel function.....	3-8
3.7	Overload protection setting	3-8
3.8	Electronic gear ratio setting.....	3-8

To make gantry control system operate normally, some features of the two axes must be the same. Before setting, ensure hardware and software configuration fits the following requirements, or it may cause danger to the stage.

- ✓ Same servo drive model
- ✓ Same firmware version
- ✓ Same positive moving direction (Check it when finishing single axis setting in section 3.1.)
- ✓ Same encoder feedback pulse resolution (Besides hardware specification, check point III in section 3.3.)

Note: Single axis may be driven in the setting process; therefore, ensure the other axis remains freely-operating status, not influenced by the brake.

3.1 Single axis setting

Gantry mode must drive the servo drives and the motors of both axes. Therefore, respectively execute single-axis initialization based on “E Series Servo Drive Thunder Software Operation Manual.” The setting procedure is shown as follows.

- I. Connect to master servo drive and execute single-axis initialization.
- II. Set and record the positive moving direction of master motor.
- III. Connect to slave servo drive and execute single-axis initialization.
- IV. Set and record the positive moving direction of slave motor, which should be the same as that of master motor.

3.2 Establish communication system

All the functions of gantry mode are based on the establishment of communication system. Therefore, communication system must be established first. The setting procedure is shown as follows.

- I. Build up the relationship of master and slave.
 - A. Connect to the left servo drive in figure 3.2.1 and set Pt00D = t.□□□1 (define it as master).
 - B. Save the parameter and power cycle the left servo drive to make it become effective.
 - C. Connect to the right servo drive in figure 3.2.1 and set Pt00D = t.□□□0 (define it as slave).
 - D. Save the parameter and power cycle the right servo drive to make it become effective.

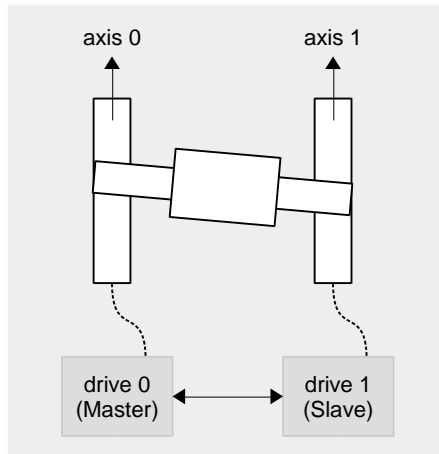

Figure 3.2.1

Table 3.2.1

Parameter		Description	Effective	Category
Pt00D	t.□□□0	Slave axis in group communication.	After power on	Setup
	t.□□□1	Master axis in group communication.		
	t.□□□2 (Default)	No gantry control.		

Note: The slave station address of ED1F-LG model must be set as 0x08, or it may cause communication error.

II. Open **Interface signal monitor** window in Thunder main window to ensure master axis' communication is established, as the red frame in figure 3.2.2 shows.

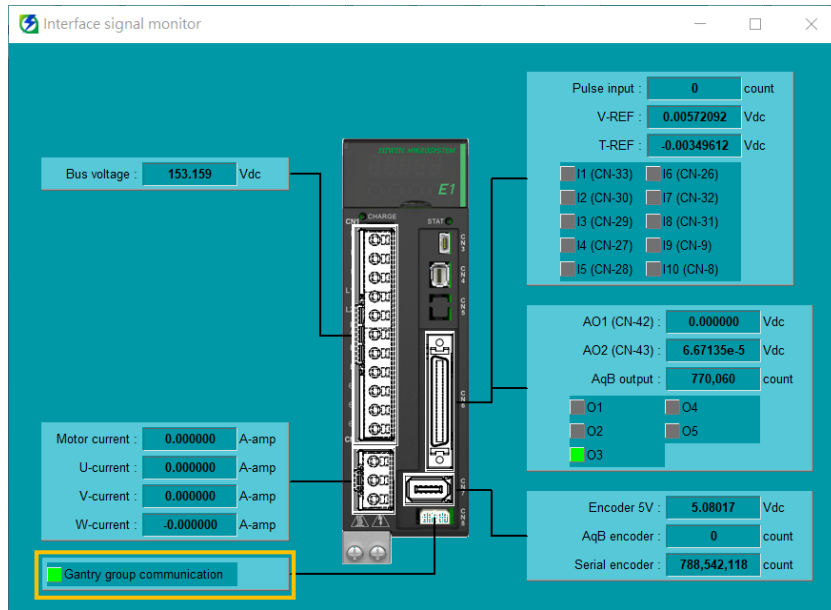

Figure 3.2.2

Note: When communication system is established, alarm AL.FC0 or AL.FC1 may be triggered if users power off any of the axes. Refer to section 5.3 for cause, confirmation method and corrective action.

3.3 Confirmation before activating gantry control system

Before activating gantry control system, double check some parameters and the resolution. The setting procedure is shown as follows.

- I. Ensure some Pt parameters of both axes are the same.
 - A. Connect to master servo drive and record Pt001, Pt20E, Pt210, Pt428, Pt402/Pt483, Pt403/Pt484.
 - B. Connect to slave servo drive and ensure the values of the parameters above are the same as those in master axis.
- II. Connect to master servo drive to ensure communication is established.
- III. Ensure the encoder resolutions of both axes are the same.
 - A. Connect to master servo drive.
 - B. Make the motor move at least one magnetic pole pair pitch with test run.
 - C. Monitor the encoder feedback of both axes via master axis' Scope. (Observe physical quantities: 17 - Master feedback position, 18 - Slave feedback position.)
 - D. Ensure the incremental direction and the ratio of encoder feedback values are the same.
- IV. When this section is completed, the two servo drives can enter gantry mode via gantry control interface.

3.4 Activate gantry control system

There are two ways to activate gantry control system, manual or auto. Manual is for Thunder HMI test run, while auto is for host controller. The setting method is shown as follows.

- **Manual**
Go to gantry control interface and click **Activate** button (refer to step 4 in chapter 7).
- **Digital**
Switch to gantry control via digital input signals in master servo drive (refer to section 3.5).
- **Auto**
Set Pt00D = t.□1□□ in master servo drive to activate auto gantry function.

Table 3.4.1

Parameter		Description	Effective	Category
Pt00D (only for master axis)	t.□0□□ (Default)	Disable auto switching for gantry control.	Immediately	Setup
	t.□1□□	Enable auto switching for gantry control.		

Note:

1. Before entering gantry mode, ensure actions in section 3.1~3.3 are completed.
2. After entering gantry mode, both axes are viewed as single linear system. Therefore, master axis test run represents linear axis test run.
3. To switch to the (gantry/single axis) control mode, both axes must be switched in the disabled status, otherwise mode switching cannot be executed.
4. If auto gantry function is activated, users cannot deactivate gantry mode via digital input signals or gantry control interface.

3.5 Digital input/output signals configuration

Digital input signal configuration:

- Gantry control input (GANTRY) signal

To switch the gantry/single axis mode via an external trigger signal, users must configure the external trigger signal to the digital input signal "GANTRY" of the master axis (linear axis). For the settings of digital input signal allocation, please refer to section 8.1.1 **Digital input signal allocation** in "E1 Series Servo Drive User Manual" and "E2 Series Servo Drive User Manual."

Type	Signal name	Hardware pin	Signal status	Description
Input	GANTRY	User-defined	Rising edge trigger	Activate gantry control system.
			Falling edge trigger	Deactivate gantry control system.

Digital output signal configuration:

- Gantry control ready output (G-RDY) signal

When the servo drive enters gantry control mode, it will output the digital output signal "G-RDY." For the settings of digital output signal allocation, please refer to section 8.1.2 **Digital output signal allocation** in "E1 Series Servo Drive User Manual" and "E2 Series Servo Drive User Manual."

Type	Signal name	Hardware pin	Signal status	Description
Output	G-RDY	User-defined	ON	Gantry control ready.
			OFF	Gantry control off.

3.6 Overtravel function

In gantry control system, overtravel (P-OT or N-OT) signal received by master and slave servo drive can only be triggered and displayed in linear servo drive. When overtravel function is enabled, the motor stopping method is set on master axis. For the setting method and details of overtravel function, refer to section 6.7 **Overtravel function** in “E1 Series Servo Drive User Manual” and “E2 Series Servo Drive User Manual.”

3.7 Overload protection setting

In gantry control system, it is recommended to synchronously set the overload protection setting in both axes. For the setting method and details of overload protection, refer to section 6.10 **Protection for motor overload** in “E1 Series Servo Drive User Manual” and “E2 Series Servo Drive User Manual.”

3.8 Electronic gear ratio setting

In gantry control system, the setting of electronic gear ratio (Pt20E, Pt210) must be synchronously modified in both axes, and the value should be the same. For the setting method and details of electronic gear ratio, refer to section 6.11 **Electronic gear ratio** in “E1 Series Servo Drive User Manual” and “E2 Series Servo Drive User Manual.”

4. Gain tuning

4.	Gain tuning.....	4-1
4.1	Single axis gain tuning	4-2
4.2	Gantry control gain tuning	4-2
4.3	Current ratio parameter	4-4
4.4	Velocity ripple compensation (not supported)	4-5

4.1 Single axis gain tuning

When to use: Before entering gantry mode, users want to move the motor by driving single axis.

In this case, the target is to make it stable. Refer to “E1 Series Servo Drive User Manual” and “E2 Series Servo Drive User Manual” for the setting method.

4.2 Gantry control gain tuning

When to use: After entering gantry mode. Pay attention to the following reminders before tuning.

- The appropriate gains for gantry control system are different from those for single axis control system. To avoid the inconvenience of switching, in single axis control system, velocity loop gain, velocity loop integral time constant, position loop gain and moment of inertia ratio are respectively Pt100, Pt101, Pt102 and Pt103. In gantry control system, they are changed to Pt190, Pt191, Pt192 and Pt193. Pt190 ~ Pt193 in master servo drive represent linear system gains, while those in slave servo drive represent yaw system gains. Other gain parameters (Pt1□□) and torque filter parameters (Pt4□□) are shared by both gantry control system and single axis control system.

Table 4.2.1

Parameter	Pt190	Range	10 ~ 20000	Control mode	Position mode and velocity mode
Default	400	Effective	Immediately	Unit	0.1 Hz
Description					
Velocity loop gain in gantry control system					

Table 4.2.2

Parameter	Pt191	Range	15 ~ 51200	Control mode	Position mode and velocity mode
Default	2000	Effective	Immediately	Unit	0.01 ms
Description					
Velocity loop integral time constant in gantry control system					

Table 4.2.3

Parameter	Pt192	Range	10 ~ 40000	Control mode	Position mode
Default	400	Effective	Immediately	Unit	0.1/s
Description					
Position loop gain in gantry control system					

Table 4.2.4

Parameter	Pt193	Range	0 ~ 50000	Control mode	Position mode and velocity mode
Default	100	Effective	Immediately	Unit	1%
Description					
Moment of inertia ratio in gantry control system					

2. The servo drive's control system is no longer single axis control. Instead, it turns into linear coordinate system and yaw coordinate system of gantry mode.
3. The position information displayed by master axis is no longer encoder position feedback of single axis; it becomes position feedback of linear coordinate system, the average value of two axes' position feedback. The position information displayed by slave axis becomes position feedback of yaw coordinate system, the deviation of two axes' position feedback.
4. Giving commands to master axis represents giving commands to linear axis direction of both axes. Besides, users can give commands to yaw axis via master axis window in gantry control interface if yaw lock function is not activated.
5. Gain parameters and protection parameters in master axis correspond to linear coordinate system; gain parameters and protection parameters in slave axis correspond to yaw coordinate system.
6. In gantry control system, tuneless function is still available. Before operating manual gain tuning, remember to close the function.
7. In gantry control system, auto tuning is still available.
8. In gantry control system, linear axis' moment of inertia ratio is approximately equal to that of single axis, while yaw axis' moment of inertia ratio is approximately equal to 1/3 times that of single axis (modify it based on requirement during usage).
9. Gantry control system only supports frequency analyzer for closed loop control. To avoid the resonance caused by poor initial gain, fill Pt103 - single axis' moment of inertia ratio in two axes' Pt193 according to the above ratio before measuring.

10. In gantry control system, master’s position deviation is judged by the difference between linear axis’ position command and the actual position, and slave’s position deviation is judged by the difference between yaw axis’ position command and the actual position. Take rigid gantry as an example, for linear axis’ setting method of Pt520 / Pt521, refer to section 10.2.3 **Setting alarm value for overflow position deviation** in “E1 Series Servo Drive User Manual” and “E2 Series Servo Drive User Manual”; for yaw axis’ setting method of Pt520 / Pt521, it is recommended to take the allowable movement amount of the mechanism as the restriction.

4.3 Current ratio parameter

In gantry control system, users can set linear axis’ and yaw axis’ distribution ratio of current as force distribution via Pt428. Linear axis’ distribution ratio will affect linear axis’ upper limit of motion specification.

For example, without considering force limit, if servo drive’s peak limit is 10 A and the Pt428 parameter value in both axes is set as 80, linear axis’ current limit will be set as 8 A, and yaw axis’ current limit will be set as 2 A, as the following figure shows. In general, the stronger the stiffness, the bigger the Pt428 parameter value should be set.

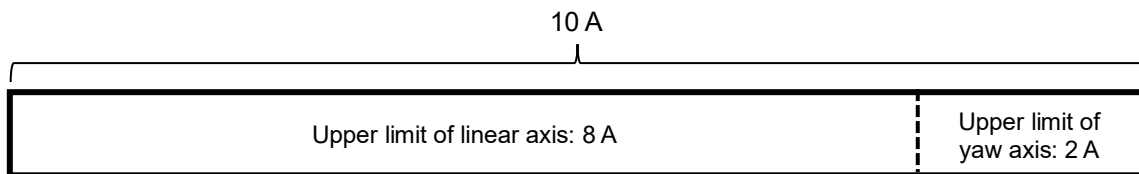

Figure 4.3.1

Since a connection relationship usually exists in the group structure of gantry control system, if yaw axis’ distribution ratio is too big, the excessive force may cause damage to the stage. Therefore, the setting of Pt428 parameter value is not recommended to be less than 70.

Table 4.3.1

Parameter	Pt428	Range	0 ~ 100	Control mode	Position mode, velocity mode and torque mode
Default	80	Effective	Immediately	Unit	1%
Description					
Current ratio of linear axis in gantry control system (synchronously modify master and slave axis)					

Note: In gantry control system, distribution ratio of current limit must be synchronously modified in both axes, and the value should be the same.

4.4 Velocity ripple compensation (not supported)

In gantry control system, servo drive does not support velocity ripple compensation.

(This page is intentionally left blank.)

5. Safety protection function

5.	Safety protection function	5-1
5.1	Enable/Disable axes in gantry control system.....	5-2
5.2	Motor stopping methods for alarm	5-2
5.3	Relevant alarms.....	5-3

Incorrectly operating gantry control system may cause damage to the stage. For safety, pay attention to the following features before entering gantry mode.

5.1 Enable/Disable axes in gantry control system

■ Enable axes

After entering gantry mode, both axes are viewed as single linear system, and master axis is in the position of control. Therefore, enabling master axis equals enabling both axes; disabling master axis equals disabling both axes.

Both axes can decide the procedure of detection for electrical angle based on master axis' Pt010 = t.□X□□. Gantry enable method 1 is only applicable to flexible gantry, and it features short enabling time. Gantry enable method 2 is the default. Although it has longer enabling time, it is applicable to all kinds of gantry structures.

■ Disable axes

When gantry control system is activated, both axes will be disabled if any axis triggers an error.

Table 5.1.1

Parameter		Description	Effective	Category
Pt010 (only for master axis)	t.□0□□	Use gantry enable method 1.	After power on	Setup
	t.□1□□ (Default)	Use gantry enable method 2.		

5.2 Motor stopping methods for alarm

In gantry control system, when an alarm occurs in linear axis, its motor stopping method is set by master servo drive's Pt parameter. Refer to section 6.9 **Motor stopping methods for servo off and alarm** in "E1 Series Servo Drive User Manual" and "E2 Series Servo Drive User Manual."

In gantry control system, when an alarm occurs in yaw axis, the setting of Pt00A = t.□□□X in slave servo drive will be ignored; only Pt001 = t.□□□X will be used.

5.3 Relevant alarms

- AL.FC0 Group control system communication error (when group communication mode is used)

Table 4.3.1

Cause	Confirmation Method	Corrective Action
Communication is interrupted. It could be disconnection of the communication cable or poor connection.	Check if the communication cable is correctly connected.	Check if the communication cable is correctly connected.
Communication is interfered.	Check if there is interference source or the communication cable is not correctly connected.	Add ferrite ring or replace the communication cable.
Power off or reset one of the axes.	N/A	Perform alarm reset on master axis via Thunder or external signal, or reset both axes.
The group control mode settings are different.	Check if the group control mode settings of both axes are the same.	Set the group control mode (Pt003 = t.□□□X) of both axes as the same value based on usage.
Communication cannot be established (only detected when auto gantry is activated).	Check if the communication cable is correctly connected.	Check if the communication cable is correctly connected.
Communication cannot be established (The station address setting of Fieldbus servo drive slave axis is abnormal).	Please check if the slave axis servo drive panel rotary switches are turned to 8.	Please turn the slave axis servo drive panel rotary switches to 8.

Note:

1. After the relationship of master and slave is built up, users should power off and reset the servo drives to make some Pt parameters become effective. Therefore, it is normal if alarm AL.FC0 occurs.
2. In gantry control interface, clearing the error or entering alarm reset input (ALM-RST) signal in master axis window represents clearing the error of both axes.

■ AL.FC1 Slave axis error in group control system (when group communication mode is used)

Table 4.3.2

Cause	Confirmation Method	Corrective Action
An error occurs in the slave axis of gantry control system.	Check the cause of the error.	After the cause of the error is cleared, perform alarm reset on master axis via Thunder or external signal, or reset both axes.

Note:

1. If any error occurs in slave axis, alarm AL.FC1 will pop up in master axis window to inform users and host controller.
2. In gantry control interface, clearing the error or entering alarm reset input (ALM-RST) signal in master axis window represents clearing the error of both axes.

6. Application function

6.	Application function	6-1
6.1	Error map.....	6-2
6.2	Torque limit function	6-4
6.3	Full-closed loop function.....	6-4
6.4	Velocity mode	6-4
6.5	Torque mode.....	6-4
6.6	Encoder pulse output	6-5
6.7	Internal homing procedure	6-5
6.8	Touch Probe procedure.....	6-11
6.8.1	HIMC with Touch Probe	6-14
6.8.2	MECHATROLINK-III with Touch Probe (not supported).....	6-14
6.9	Position trigger function.....	6-15

6.1 Error map

■ Linear axis

In gantry control system, the requirements for activating linear axis' error map:

(1) Complete "linear axis homing procedure." (2) Set Pt009 = t.1□□1 in master servo drive.

The usage is similar to that of single axis. The differences are that the sources are from linear axis' original positions and that the positions of linear axis will be compensated, not the positions of single axis. The setting procedure is shown as follows.

- I. Set up linear axis' error map and save it to master servo drive (refer to "E Series Servo Drive Thunder Software Operation Manual").
- II. Set Pt009 = t.1□□1 in master servo drive.
- III. Activate gantry control system.
- IV. Execute homing procedure.
- V. If Pt00F = t.□0□□ (Default) is set in master, after homing is completed and the motor is disabled, it will become effective; if Pt00F = t.□1□□ is set in master, after homing is completed, it will become effective.

■ Yaw axis

In gantry control system, the requirements for activating yaw axis' error map:

(1) Complete "linear axis homing procedure." (2) Set Pt009 = t.1□□1 in slave servo drive.

The sources are also from linear axis' original positions, but the positions of yaw axis will be compensated. The setting procedure is shown as follows.

- I. Set up yaw axis' error map and save it to slave servo drive (refer to "E Series Servo Drive Thunder Software Operation Manual").
- II. Set Pt009 = t.1□□1 in slave servo drive.
- III. Connect to master servo drive and activate gantry control system.
- IV. Execute homing procedure.
- V. If Pt00F = t.□0□□ (Default) is set in slave, after homing is completed and the motor is disabled, it will become effective; if Pt00F = t.□1□□ is set in slave, after homing is completed, it will become effective.

Table 6.1.1

Parameter		Description	Effective	Category
Pt009	t.□□□0 (Default)	After internal homing is completed, enable error map function for single axis.	After power on	Setup
	t.□□□1	After internal homing is completed, enable error map function for gantry axis.		
	t.□□□2	Automatically enable error map function for specific motor.		
	t.□□□3	After Touch Probe homing is completed, enable error map function for single axis.		
	t.□□□4	After Touch Probe homing is completed, enable error map function for gantry axis.		

Table 6.1.2

Parameter		Description	Effective	Category
Pt009	t.0□□□ (Default)	Disable error map function.	Motor is disabled	Setup
	t.1□□□	Enable error map function.		

Table 6.1.3

Parameter		Description	Effective	Category
Pt00F	t.□0□□ (Default)	Disable function of automatically activating error map.	After power on	Setup
	t.□1□□	Enable function of automatically activating error map.		

6.2 Torque limit function

In gantry control system, the setting of torque limit parameters Pt402 / Pt483, Pt403 / Pt484 and external torque limit parameters Pt404, Pt405 must be synchronously modified in both axes, and the value should be the same. For the setting method and details of torque limit function, refer to section 8.10 **Torque limit function** in “E1 Series Servo Drive User Manual” and “E2 Series Servo Drive User Manual.”

6.3 Full-closed loop function

In gantry control system, the travel distance, feed constant and resolution of both axes must be the same. For the setting method and details of full-closed loop function, refer to section 8.16 **Full-closed loop function** in “E1 Series Servo Drive User Manual” and “E2 Series Servo Drive User Manual.”

6.4 Velocity mode

In gantry control system, set Pt000 = t.□□0□ (control method selection is velocity mode) in master servo drive. For the setting method and details of velocity mode, refer to section 8.3 **Velocity mode** in “E1 Series Servo Drive User Manual” and “E2 Series Servo Drive User Manual.”

6.5 Torque mode

In gantry control system, set Pt000 = t.□□2□ (control method selection is torque mode) in master servo drive. For the setting method and details of torque mode, refer to section 8.5 **Torque mode** in “E1 Series Servo Drive User Manual” and “E2 Series Servo Drive User Manual.”

6.6 Encoder pulse output

In gantry control system, the setting of Pt207 = t.□□□X decides the behavior of encoder output. If Pt207 = t.□□□1 (enable buffered encoder output), servo drive will take the single-axis original encoder signal as output. If Pt207 = t.□□□0 (disable buffered encoder output), master servo drive will output linear position's pulse signal to host controller according to the set encoder output ratio, and slave servo drive will not output anything.

6.7 Internal homing procedure

After entering gantry mode, both axes are viewed as single linear system. Therefore, homing methods applied in single axis control system (refer to “E1 Series Servo Drive User Manual” and “E2 Series Servo Drive User Manual” for the description) are applicable for gantry control system. The setting procedure is shown as follows.

Linear axis homing procedure

- I. Ensure both axes have entered gantry mode.
- II. Connect to linear servo drive via Thunder HMI or host controller.
- III. Set homing method.
- IV. Enable the motors. Execute homing via Thunder HMI, or trigger servo drive built-in homing procedure input (HOM) signal via host controller.
- V. Complete slave axis' homing procedure and master axis' homing procedure, as figure 6.7.1 shows.

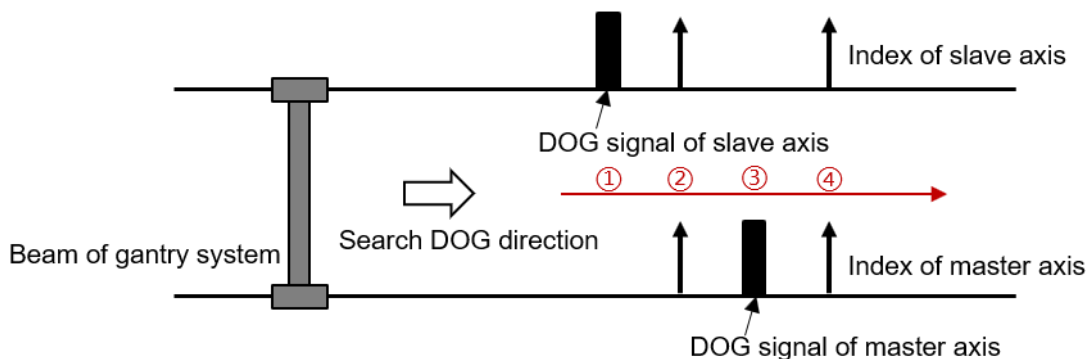

Figure 6.7.1

At this time, users only complete “linear axis homing procedure.” Go on to complete “posture regulating setting.”

Posture regulating setting

- VI. Disable the motors at home position.
- VII. (Optional) Record the posture position of yaw axis with Scope, add a negative sign to the value, and fill it in master axis' **Pt711 - Home offset of yaw axis in gantry control system**. That is, offset the home position of yaw axis. At this time, the posture position of yaw axis will be close to 0.
- VIII. Record the posture position of yaw axis with Scope, and set the record value to master axis' **Pt712 - Locking position of yaw axis in gantry control system**. (If step VII is done, directly set master axis' Pt712 as 0.)
- IX. Set master axis' Pt710 = t.□□□1 to activate yaw lock function.
- X. Enable the motors. Yaw axis will be locked at the position set by master axis' Pt712.

When yaw lock function is activated and the parameters are saved to servo drives, posture regulating setting is done. Even if the stage is power cycled, linear/yaw axis will remain at home posture after users trigger and complete "linear axis homing procedure" via Thunder HMI or host controller.

Table 6.7.1

Parameter		Description	Effective	Category
Pt710 (only for master axis)	t.□□□0 (Default)	Disable yaw axis locking function for gantry control system.	Immediately	Setup
	t.□□□1	Enable yaw axis locking function for gantry control system.		

The requirements for activating yaw lock function:

- (1) Enable yaw axis locking function for gantry control system. (2) Complete "linear axis homing procedure."

Table 6.7.2

Parameter	Pt711	Range	-1073741824 ~ 1073741824	Control mode	Position mode
Default	0	Effective	Immediately	Unit	1 control unit
Description					
Home offset of yaw axis in gantry control system (only for master axis)					

Table 6.7.3

Parameter	Pt712	Range	-1073741824 ~ 1073741824	Control mode	Position mode
Default	0	Effective	Immediately	Unit	1 control unit
Description					
Locking position of yaw axis in gantry control system (only for master axis)					

■ Definition of terms

- (1) Home position of linear axis:
the center of two axes' indexes (as figure 6.7.2 shows)

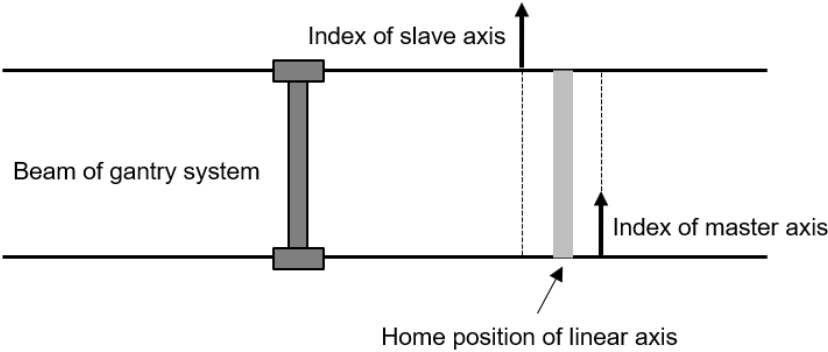

Figure 6.7.2

- (2) Home position of yaw axis:
the posture that the two axes' indexes take as the supporting point (as figure 6.7.3 shows)
Before master axis' Pt711 is set, a physical installation deviation of mechanism exists in two axes' indexes. Home posture of yaw axis is usually not orthogonal to the linear axis. Therefore, it is reasonable that there is a nonzero value in yaw axis after homing is completed.

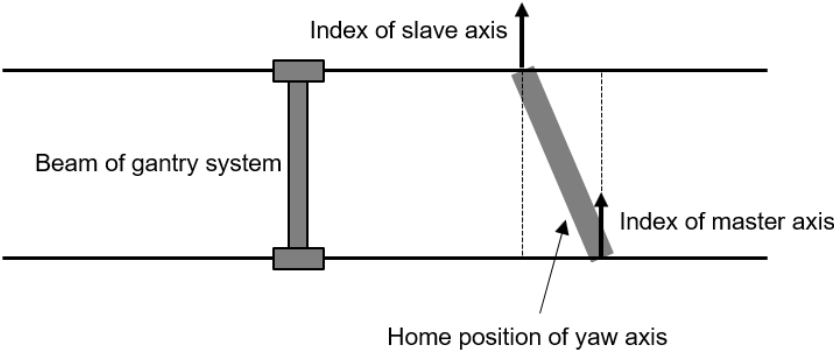

Figure 6.7.3

- (3) Home offset of yaw axis in gantry control system (Optional): the offset of yaw axis' home position
 Since the physical installation deviation existing in indexes makes the home posture of yaw axis not be orthogonal to the linear axis, users can modify the home position of yaw axis via master axis' Pt711. After the modification, the display position of yaw axis will change.
- (4) Locking position of yaw axis in gantry control system: After homing is completed and yaw lock function is activated, yaw axis will be locked at the setting position. If there is a value in Pt711, yaw axis will be locked at the offset position.

Note:

- 1. Overtravel (P-OT or N-OT) signal received by master and slave servo drive can only be triggered in linear servo drive. Therefore, triggering any axis' overtravel signal satisfies the triggering overtravel signal procedure of homing.
- 2. In gantry control system, before yaw lock function is activated, the posture of yaw axis when the motors are enabled will be taken as the reference position to make the mechanism be at a comfortable state. Therefore, the posture of yaw axis will not be arbitrarily changed.

■ Search DOG signal setting

If searching DOG signal procedure is included in homing procedure, set the searching method based on encoder type. With a multi index encoder, set master axis' **Pt710 = t.□□0□ - Search DOG signal in both axes** to avoid searching different indexes. With a single index encoder, the problem mentioned above will not happen, so users can set master axis' **Pt710 = t.□□1□ - Search DOG signal only in master axis.**

Table 6.7.4

Parameter		Description	Effective	Category
Pt710 (only for master axis)	t.□□0□ (Default)	Search DOG signal in both axes.	Immediately	Setup
	t.□□1□	Search DOG signal only in master axis.		

Note: "Search DOG signal only in master axis" is only applicable to single index encoder.

■ Search DOG signal in both axes

(1) Searching steps

In gantry control system, the homing searching sequence of slave axis is prior to that of master axis. The first step of linear axis homing procedure is reading slave axis' near home sensor (DOG signal) at the velocity for finding near home sensor (Pt701) and detecting slave axis' index signal at the velocity for finding home position (Pt702); the second step is reading master axis' near home sensor at the velocity for finding near home sensor (Pt701) and detecting master axis' index signal at the velocity for finding home position (Pt702), as figure 6.7.4 shows. If positive/negative limit is touched during the process of searching near home sensor, it will return based on the homing method and execute the subsequent homing procedure. Refer to section 8.11 **Internal homing** in "E1 Series Servo Drive User Manual" and "E2 Series Servo Drive User Manual" for homing methods.

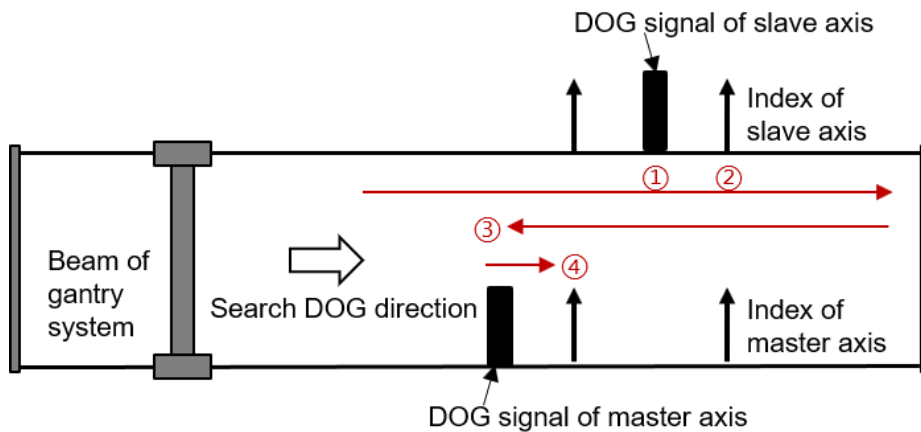

Figure 6.7.4

■ Search DOG signal only in master axis

When a single index encoder is used with near home sensors, install the near home sensor on master axis side and before both axes' indexes, as figure 6.7.5 shows.

(1) Searching steps

In gantry control system, it only detects master axis' near home sensor (DOG signal). The first step of linear axis homing procedure is reading master axis' near home sensor at the velocity for finding near home sensor (Pt701), and the second step is detecting both axes' index signals at the velocity for finding home position (Pt702), as figure 6.7.5 shows. Refer to section 8.11 **Internal homing** in "E1 Series Servo Drive User Manual" and "E2 Series Servo Drive User Manual" for homing methods.

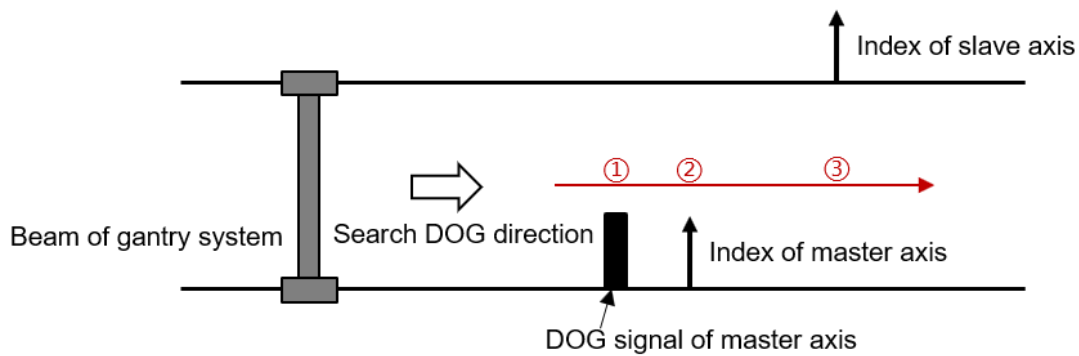

Figure 6.7.5

Note:

1. If overtravel (P-OT or N-OT) signal is received during the process of searching home position, homing will fail.
2. Time limit for homing procedure is the total time of both axes' homing procedures, and it is set to Pt703.
3. Internal homing procedure will not be influenced by the setting of Pt710 = t.□X□□.
4. For "Search DOG signal only in master axis," there is no priority of detecting master and slave axis' index signal.

6.8 Touch Probe procedure

On gantry mode, Fieldbus type EtherCAT model and mega-ulink model support Touch Probe procedure executed with host controller.

Linear axis Touch Probe procedure

- I. Ensure both axes have entered gantry mode.
- II. Connect to linear servo drive via host controller.
- III. Enable the motors via host controller and activate Touch Probe procedure.
(Refer to table 6.8.1 and table 6.8.2 for the related objects.)
- IV. After the index positions of both axes are triggered and reported to host controller, Touch Probe procedure is completed.

At this time, users only complete “linear axis Touch Probe procedure.” Go on to complete “posture regulating procedure” and “posture regulating setting.”

Posture regulating procedure

- V. Set object 3057h as 11 to execute yaw axis regulating procedure.
After it is completed, users will find out that bit11 of object 3056h is 1.
(Yaw axis regulating is completed.)

Posture regulating setting the same as that in section 6.7

- VI. Disable the motors at the position.
- VII. (Optional) Record the posture position of yaw axis with Scope, add a negative sign to the value, and fill it in master axis' **Pt711 - Home offset of yaw axis in gantry control system**. That is, offset the home position of yaw axis. At this time, the posture position of yaw axis will be close to 0.
- VIII. Record the posture position of yaw axis with Scope, and set the record value to master axis' **Pt712 - Locking position of yaw axis in gantry control system**. (If step VIII is done, directly set master axis' Pt712 as 0.)
- IX. Set master axis' Pt710 = t.□□□1 to activate yaw lock function.
- X. Enable the motors. Yaw axis will be locked at the position set by master axis' Pt712.

When yaw lock function is activated and the parameters are saved to servo drives, posture regulating setting is done. Even if the stage is power cycled, linear/yaw axis will remain at home posture after users execute “linear axis Touch Probe procedure” and “posture regulating procedure” via host controller.

Note:

- The dictionary list and the introduction of the related objects are shown as follows.

Table 6.8.1

Index	Sub-index	Name	Data type	Access	PDO	Operation mode	Valid value	Unit
3056h	00h	Software state	U16	ro	-	All	0 ~ 65536	-
3057h	00h	Apply mode of gantry system	U16	rw	-	All	0 ~ 65536	-
3058h	00h	Yaw target position	I32	rw	Y	All	-2147483648 ~ 2147483647	inc
3059h	00h	Yaw feedback position	I32	ro	Y	All	-2147483648 ~ 2147483647	inc

Table 6.8.2

#	Index	Definition
(1)	3056h	bit8 0: Gantry is not activated. 1: Gantry is activated.
		bit11 0: Yaw axis regulating is not completed. 1: Yaw axis regulating is completed.
		bit12 0: Yaw axis is not in-position. 1: Yaw axis is in-position.
(2)	3057h	1: Activate gantry. 2: Deactivate gantry. 11: Execute yaw axis regulating.

- On gantry mode, Touch Probe value is not the index position of any single axis. Instead, it is the center point of both axes' index positions, as figure 6.8.1 shows.

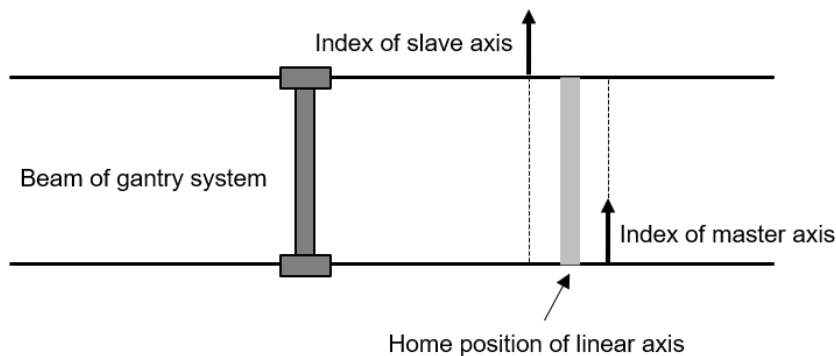

Figure 6.8.1

■ With a single index encoder

When a single index encoder is used with near home sensors, install the near home sensor on master axis side and before both axes' indexes, as figure 6.8.2 shows.

(1) Searching steps

In gantry control system, it only detects master axis' near home sensor (DOG signal). The first step of Touch Probe procedure is reading master axis' near home sensor, and the second step is detecting both axes' index signals, as figure 6.8.2 shows.

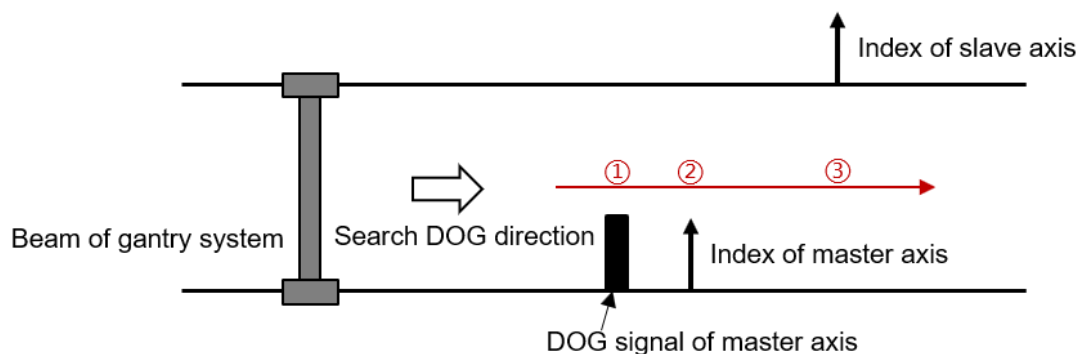

Figure 6.8.2

■ With a multi index encoder

When a multi index encoder is used with near home sensors, please note the following:

(1) Use Pt parameter

In gantry control system, Touch Probe procedure with a multi index encoder must adopt the detection of near home sensors. However, the near home sensor read by host controller only represents master axis' signal. With slave axis' **Pt710 = t.□X□□ - Option of searching index signal for slave axis**, slave axis' servo drive can detect near home sensor and index signal based on the setting.

Table 6.8.3

Parameter		Description	Effective	Category
Pt710 (only for slave axis)	t.□0□□ (Default)	Search index signal only.	Immediately	Setup
	t.□1□□	Search index signal after rising edge of DOG signal is found.		
	t.□2□□	Search index signal after falling edge of DOG signal is found.		

(2) Searching steps

In gantry control system, the detection timing of near home sensor (DOG signal) for slave axis is later than that for master axis. The first step of Touch Probe procedure is reading master axis' near home sensor, and the second step is detecting both axes' index signals. (The way to detect slave axis' index signal is determined by slave axis' Pt710 = t.□X□□.) Therefore, to normally read the position of slave axis' near home sensor, it cannot be in front of the position of master axis' near home sensor, as figure 6.8.3 shows.

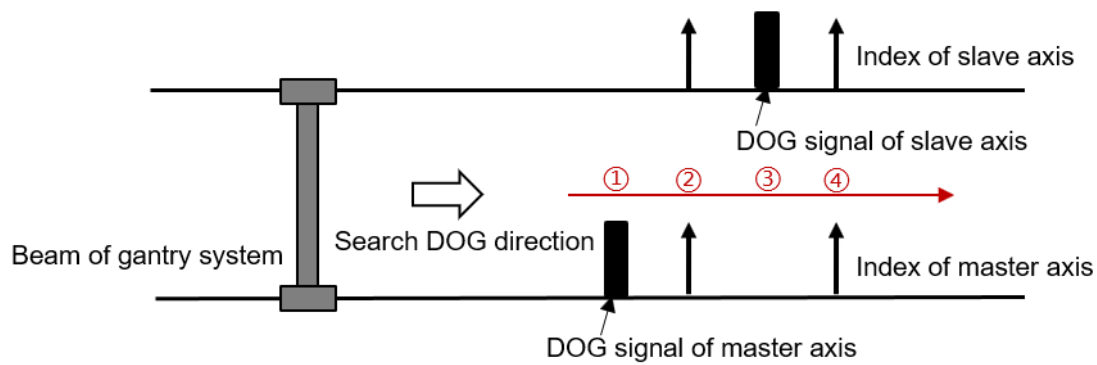

Figure 6.8.3

6.8.1 HIMC with Touch Probe

For the homing method and details of HIMC with Touch Probe, refer to section 20.1.2 **User-defined homing procedure** in “HIMC HMPL User Guide.” The servo drive parameters corresponding to the objects are shown in the following table.

Table 6.8.1.1

Object		Corresponding Servo Drive Parameter
3057h		gantry.apply_mode
3056h	Bit 11	X_yaw_align

6.8.2 MECHATROLINK-III with Touch Probe (not supported)

In gantry control system, MECHATROLINK-III with Touch Probe is not supported.

6.9 Position trigger function

In gantry control system, the position trigger function is only applicable to the gantry master axis. After the position trigger function is on, the axis will output the position trigger signal (PT) based on the coordinates of the linear axis. Please execute the following steps before enabling the position trigger function:

Step 1: Please refer to section 8.13 **Setting position trigger function** in “E1 Series Servo Drive User Manual” and “E2 Series Servo Drive User Manual” to complete the related parameter settings of position trigger function.

Step 2: After enabling the gantry control system, complete the internal homing procedure in section 6.7 or the Touch Probe procedure in section 6.8 according to the homing method selection for position trigger function (Pt00E=t.X).

Step 3: Enable the position trigger function.

Note:

1. The gantry control system supports the position trigger function in firmware version 2.12.0/3.11.0 and above.
2. After re-executing the homing process or posture regulating setting, please turn off the position trigger function and then turn it on again.

(This page is intentionally left blank.)

7. Gantry control interface setting

7. Gantry control interface setting	7-1
---	-----

Here takes linear motor as an example to show the setting of gantry control interface.

- Step 1. Presetting of gantry control (refer to section 3.1~3.3)
- Step 2. Open **Gantry control system** window
 - (1) Select **Gantry control system** in **Tools**.
 - (2) Ensure the status light of **Group communication** lights up in green (which means the communication between Master and Slave is fine), as figure 7.1 shows.
 - (3) Ensure the status light of **Firmware matched** lights up in green, as figure 7.2 shows.
 - (4) Click  to open **Parameters Setup** window and adjust Slave's parameters in **Slave Para.** Tab, as figure 7.3 shows.

Note:

- 1. If Master is used with E1 firmware version prior to 2.8.16 (or included) and E2 firmware version prior to 3.9.20 (or included), **Gantry control system** window is shown as figure 7.4. There is no status light of **Firmware matched** and  icon.
- 2. When the setting of Master and Slave is done, operate Master to start gantry control.

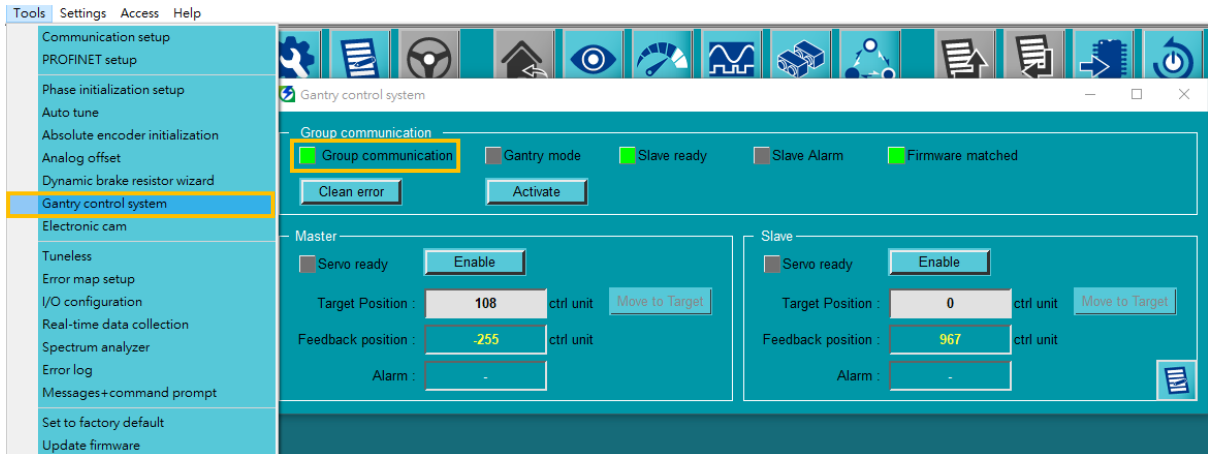

Figure 7.1 Open **Gantry control system** window



Figure 7.2 Status light of **Firmware matched**

Diff	Pt0XX	Pt1XX	Pt2XX	Pt3XX	Pt4XX	Pt5XX	Pt6XX	Pt7XX	Slave Para.	Others
<input type="checkbox"/>									<input type="checkbox"/>	
Parameter Name	Default Value	Modified Value	Unit	Description						
S.Pt193 (I)	100	101	1%	[Moment of inertia ratio in gantry control system]						
S.Pt428 (I)	80	80	1%	[Current ratio of linear axis in gantry control system]						
S.Pt483 (I)	30	30	1% (rated force)	[Forward force limit value for internal force limit (linear ser...						
S.Pt484 (I)	30	30	1% (rated force)	[Reverse force limit value for internal force limit (linear ser...						

Figure 7.3 Adjust Slave's parameters from Master

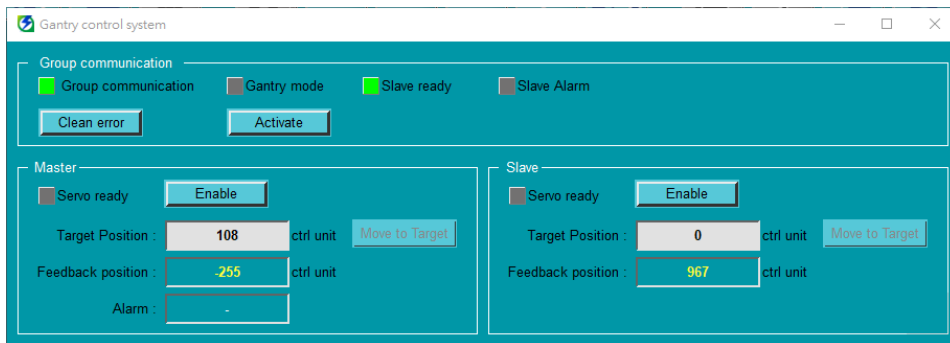

Figure 7.4 Open **Gantry control system** window:

with E1 firmware version prior to 2.8.16 (or included) and E2 firmware version prior to 3.9.20 (or included)

Step 3. Respectively enable Master and Slave

- (1) Click **Enable** button of Master. When the motor is enabled, the status light of **Servo ready** in Master will light up in green. Click **Disable** button of Master.
- (2) Click **Enable** button of Slave. When the motor is enabled, the status light of **Servo ready** in Slave will light up in green. Click **Disable** button of Slave.

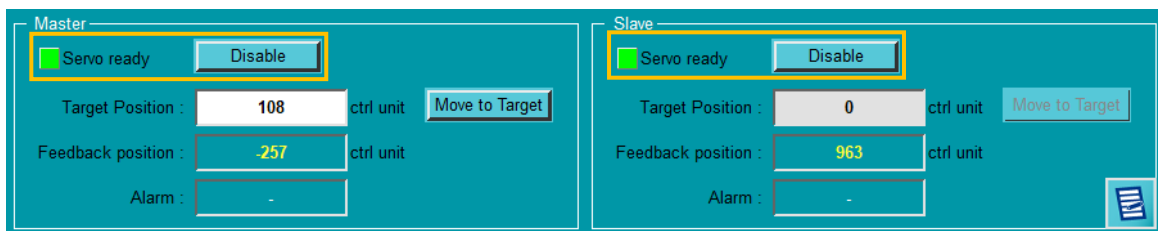

Figure 7.5 Enable Master and Slave

Step 4. Start gantry control

- (1) Click **Activate** button and wait for the status light of **Gantry mode** to light up in green.
- (2) When it succeeds, the label of **Master** and **Slave** will become **Linear** and **Yaw**.

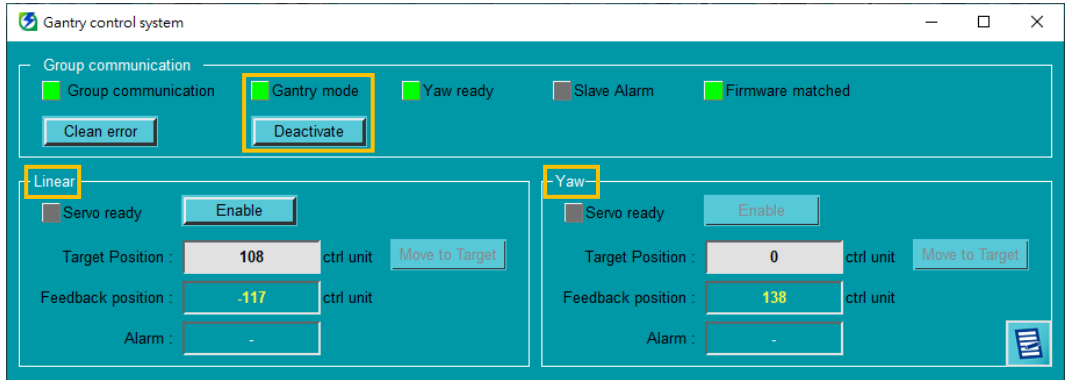

Figure 7.6 Start gantry control

Step 5. Enable axes on gantry mode

- (1) Click **Enable** button of Linear. At this time, both axes are enabled, and both the status lights of **Servo ready** in Linear and Yaw light up in green.
- (2) After ensuring the axes can be normally enabled, click **Disable** button of Linear to disable the motors.

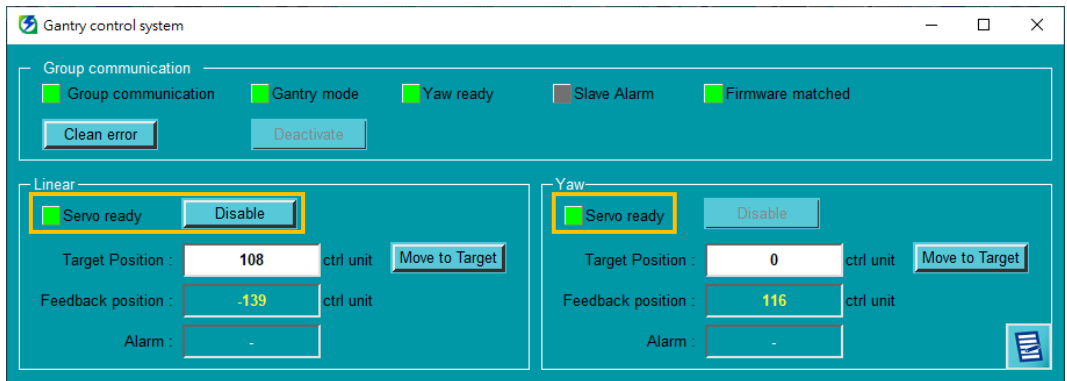



Figure 7.7 Enable status on gantry mode

Step 6. Test run on gantry mode

Close **Gantry control system** window. Click  to open **Test Run** window and observe the synchronous effect on gantry mode with low velocity jog (e.g., 50 mm/s).

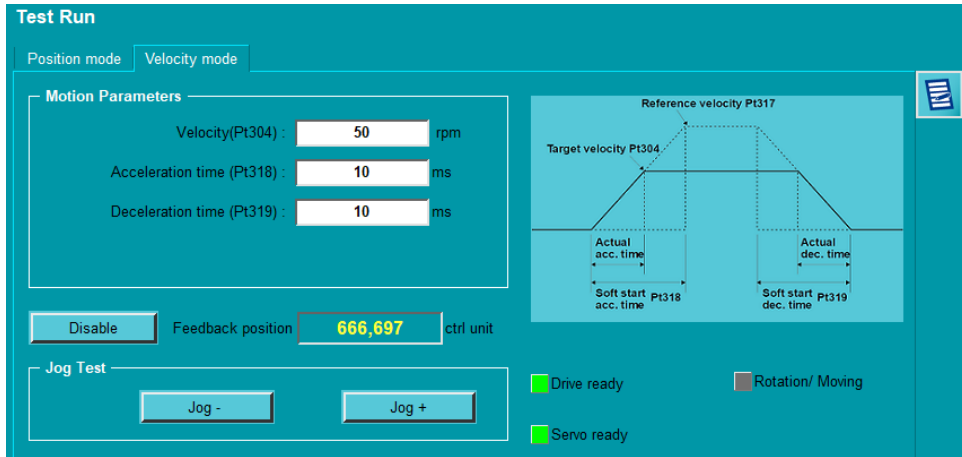



Figure 7.8 Low velocity jog on gantry mode

Step 7. Observe the position of linear axis / yaw axis / single axis

Click  to open **Real-time Scope** window and select the items to be monitored. The relevant physical quantities for gantry control system include “2 - Feedback position,” “19 - Yaw position,” “17 - Master feedback position” and “18 - Slave feedback position.”

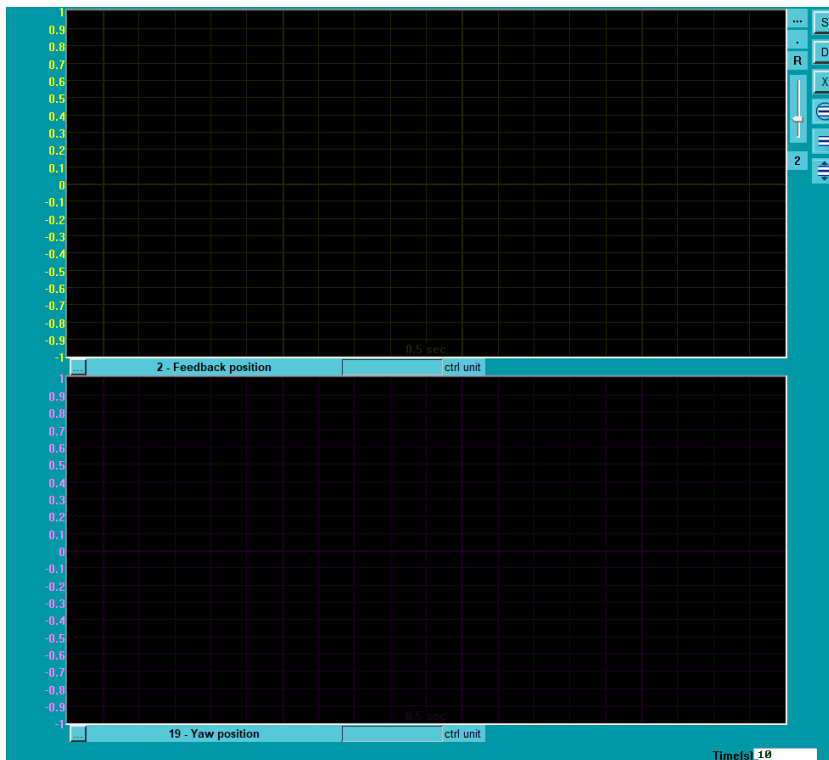

Figure 7.9 Monitor the relevant physical quantities for gantry control system via Real-time Scope

(This page is intentionally left blank.)